

## CARALIS 1

Faretto fisso con 1LED da 1W  
Spotlight with 1LED 1W

CE III F IP65  $\varnothing$  30

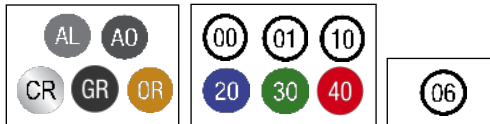

Cod. 426-01	Finitura . Finish	Colore LED . LED color	Focale . Focal
-------------	-------------------	------------------------	----------------

### Caratteristiche tecniche - Product Features

Corpo faretto	acciaio inox AISI 316L e alluminio
Potenza	1W
Temperatura di colore bianco	3000°K - 4000°K - 5500°K
Lato frontale	trasparente
Collegamento	in serie
Alimentazione Voltaggio	corrente continua 350mA
Grado di protezione	IP65
Installazione	tramite molle

Spotlight material	316L stainless steel and aluminum
Power	1W
Color temperature	3000°K - 4000°K - 5500°K
Front glass	transparent
Connection	serial connection
Supply current	350mA constant
Degree of protection	IP65
Installation	by means of springs

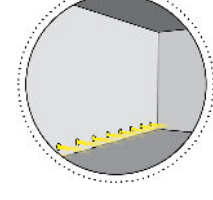
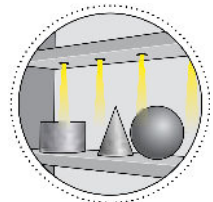
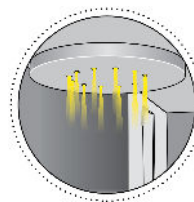

### “Controllo Assistente Smart” \*

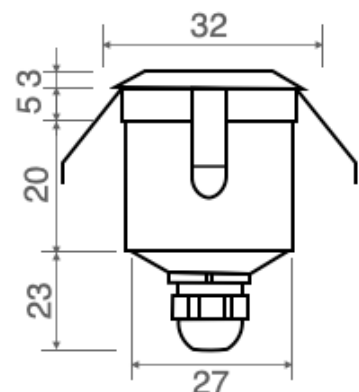
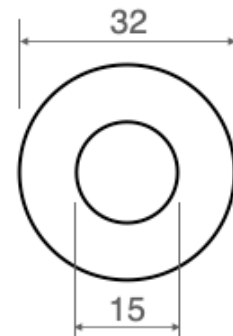
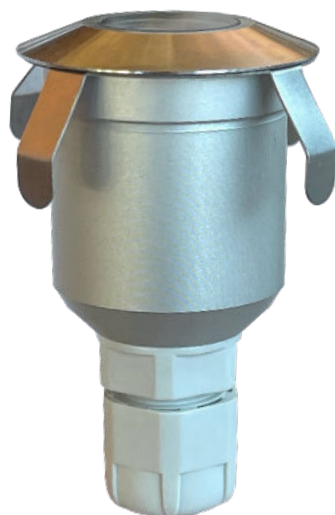

\*su richiesta  
on request

# LEGENDA • LEGEND

## SIMBOLI APPLICAZIONI . APPLICATION SYMBOLS

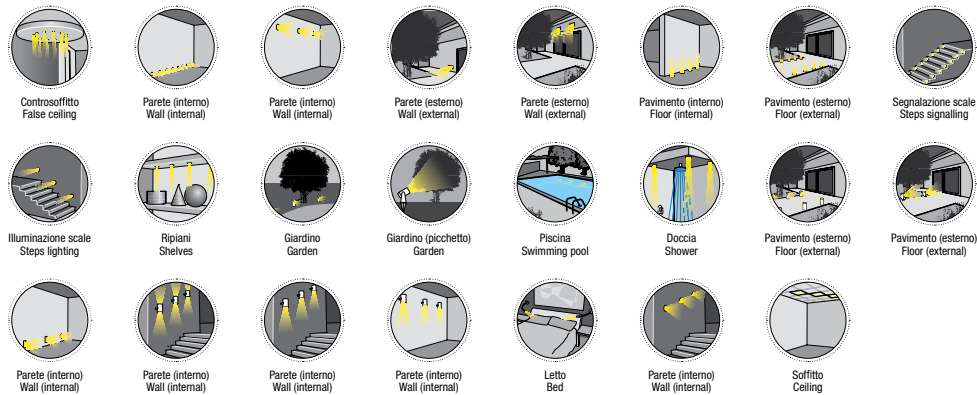

## LEGENDA PER COMPLETAMENTO CODICE PRODOTTO . KEY FOR CODE CREATION

Codice base . Base code	Finitura . Finishing	Colore LED . LED colour	Focale . Beam spread
-------------------------	----------------------	-------------------------	----------------------

### FINITURA . FINISHING

AL Acciaio inox lucido Polished stainless steel	AO Acciaio inox opaco Matt stainless steel	AS Acciaio inox spazzolato Brushed stainless steel	PC Policarbonato Polycarbonate
KS Nichel satinato Frosted nickel	CR Cromo Chrome	OR Oro Gold	NR Nero Black
PL Plexiglass Plexiglass	CA Acrilico pieno satinato Full acrylic, satin finish	DB Delrin bianco White delrin	DN Delrin nero Black delrin
TI Titanio Titanium	PM PMMA PMMA	VR Verde Green	BR Bronzo Bronze
	BL Blu Blue	AT Antracite Anthracite	VT Vetro temperato Tempered glass

### COLORE LED . LED COLOURS

00 Bianco 3300K White 3300K	01 Bianco 4200K White 4200K	10 Bianco 5500K White 5500K
20 Blu Blue	30 Verde Green	40 Rosso Red
50 Arancione Orange	99 LED Rgb Rgb LEDs	

### FOCALE LENTE . BEAM SPREAD

00 Luce diffusa Diffuse light	01 10°	02 15°	03 30°	04 45°	05 60°
06 120°	07 25°	08 35°	09 40°	10 50°	88 Multifocale Multifocal

## LEGENDA SIMBOLI . SYMBOLS DESCRIPTION



Calpestabile  
Walk over



Carrabile  
Drive over



Illuminazione 1 lato  
One side light emission



Illuminazione 2 lati  
Both sides light emission



Prodotto realizzato  
completamente in Italia  
Original Italian product



LED Rgb Full Colour  
Rgb Full Colour

CE	Conforme alle direttive CE Conformity with CE directive	⚠	Apparecchio idoneo per il montaggio su superfici normalmente infiammabili Equipment suitable to be fitted on normally inflammable surface	⚙	Apparecchio dimmerabile Dimmerable equipment	🏠	Outdoor Outdoor
⚡	Classe 3 - Apparecchi alimentati con tensione di sicurezza inferiore ai 50V Class 3 - Equipment powered with safety voltage lower than 50V	IP--	Grado di protezione alla penetrazione di solidi e liquidi Resistance of the fitting to the penetration of solid and liquids	🔗	Dimensioni dei fori da praticare per l'incasso Hole dimensions	🏠	Indoor Indoor

## LEGENDA SIMBOLI . SYMBOLS DESCRIPTION

IP20	Protetto contro corpi solidi $\phi \geq 12\text{mm}$ . - Protected against solid bodies $\phi \geq 12\text{mm}$ .	IP54	Protetto contro la polvere e contro gli spruzzi d'acqua. - Dust-proof and splash-proof.
IP23	Protetto contro corpi solidi $\phi \geq 12\text{mm}$ e contro la pioggia fino a 60° dall'asse verticale. Protected against solid bodies $\phi \geq 12\text{mm}$ and against rain up to 60° from vertical axis.	IP55	Protetto contro la polvere e contro i getti d'acqua. - Dust-proof and splash-proof.
IP33	Protetto contro corpi solidi $\phi \geq 2,5\text{mm}$ e contro la pioggia fino a 60° dall'asse verticale. Protected against solid bodies $\phi \geq 2,5\text{mm}$ and against rain up to 60° from vertical axis.	IP65	Totamente protetto contro la polvere e contro i getti d'acqua. - Dust-tight and jet-proof.
IP40	Protetto contro corpi solidi $\phi \geq 1\text{mm}$ . - Protected against solid bodies $\phi \geq 1\text{mm}$ .	IP66	Totamente protetto contro la polvere e contro i getti d'acqua in pressione. Dust-tight and powerful jet-proof.
IP43	Protetto contro corpi solidi $\phi \geq 1\text{mm}$ e contro la pioggia fino a 60° dall'asse verticale. Protected against solid bodies $\phi \geq 1\text{mm}$ and against rain up to 60° from vertical axis.	IP67	Totamente protetto contro la polvere e stagno all'immersione. Dust-tight and water tight (immersible).
IP44	Protetto contro corpi solidi $\phi \geq 1\text{mm}$ e spruzzi d'acqua. Protected against solid bodies $\phi \geq 1\text{mm}$ and splash-proof.	IP68	Totamente protetto contro la polvere e stagno alla sommersione. Dust-tight and water tight (submersible).