

DUBRIS 1

Faretto orientabile con 1LED da 1W
Adjustable spotlight with 1LED 1W

CE III F IP 40

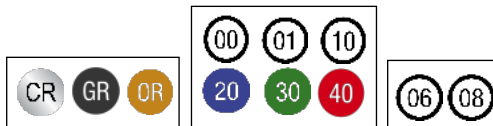

Cod. 422-01	Finitura . Finish	Colore LED . LED color	Focale . Focal
-------------	-------------------	------------------------	----------------

Caratteristiche tecniche - Product Features

Corpo faretto	alluminio
Potenza	1W
Temperatura di colore bianco	3000°K - 4000°K - 5500°K
Lato frontale	trasparente
Collegamento	in serie
Alimentazione Voltaggio	corrente continua 350mA
Grado di protezione	IP40
Installazione	tramite viti

Spotlight material	aluminum
Power	1W
Color temperature	3000°K - 4000°K - 5500°K
Front glass	transparent
Connection	serial connection
Supply current	350mA constant
Degree of protection	IP40
Installation	by means of screws

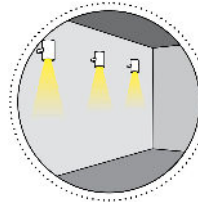
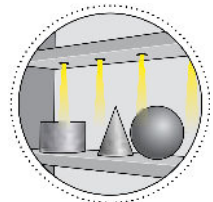
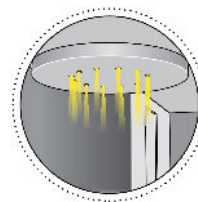

"Controllo Assistente Smart" *

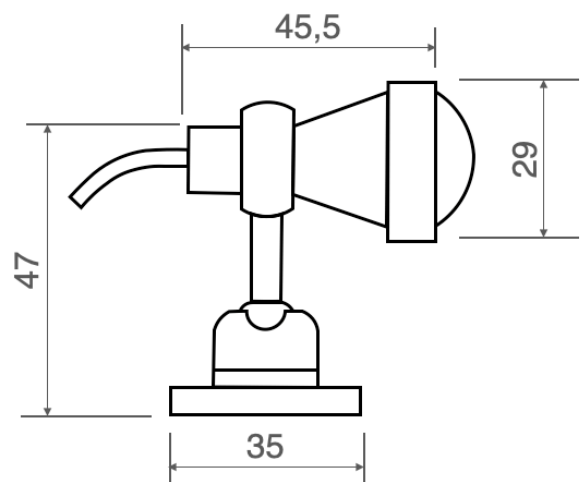

*su richiesta
on request

LEGENDA • LEGEND

SIMBOLI APPLICAZIONI . APPLICATION SYMBOLS

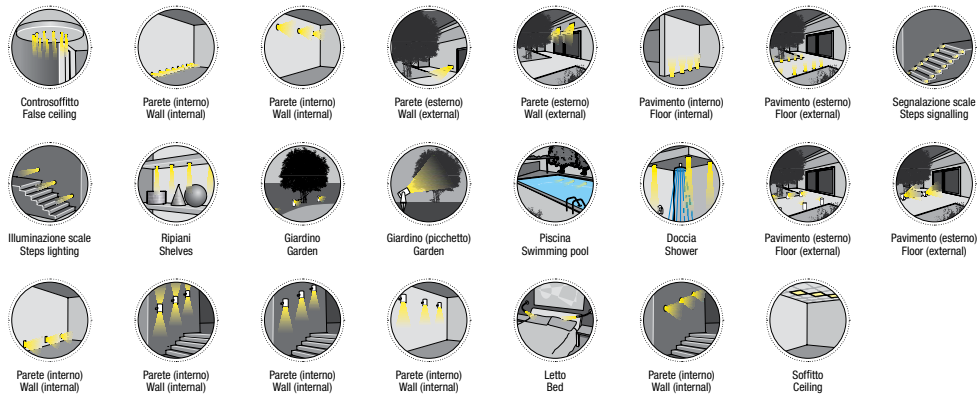

LEGENDA PER COMPLETAMENTO CODICE PRODOTTO . KEY FOR CODE CREATION

Codice base . Base code	Finitura . Finishing	Colore LED . LED colour	Focale . Beam spread
-------------------------	----------------------	-------------------------	----------------------

FINITURA . FINISHING



COLORE LED . LED COLOURS



FOCALE LENTE . BEAM SPREAD

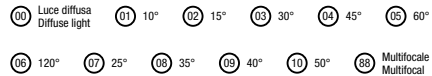

LEGENDA SIMBOLI . SYMBOLS DESCRIPTION



Calpestabile
Walk over



Carrabile
Drive over



Illuminazione 1 lato
One side light emission



Illuminazione 2 lati
Both sides light emission



Prodotto realizzato
completamente in Italia
Original Italian product



LED Rgb Full Colour
Rgb Full Colour

CE	Conforme alle direttive CE Conformity with CE directive	⚠	Apparecchio idoneo per il montaggio su superfici normalmente infiammabili Equipment suitable to be fitted on normally inflammable surface	⚙	Apparecchio dimmerabile Dimmerable equipment	🏠	Outdoor Outdoor
⚡	Classe 3 - Apparecchi alimentati con tensione di sicurezza inferiore ai 50V Class 3 - Equipment powered with safety voltage lower than 50V	IP--	Grado di protezione alla penetrazione di solidi e liquidi Resistance of the fitting to the penetration of solid and liquids	📏	Dimensioni dei fori da praticare per l'incasso Hole dimensions	🏠	Indoor Indoor

LEGENDA SIMBOLI . SYMBOLS DESCRIPTION

IP20	Protetto contro corpi solidi $\phi \geq 12\text{mm}$. - Protected against solid bodies $\phi \geq 12\text{mm}$.	IP54	Protetto contro la polvere e contro gli spruzzi d'acqua. - Dust-proof and splash-proof.
IP23	Protetto contro corpi solidi $\phi \geq 12\text{mm}$ e contro la pioggia fino a 60° dall'asse verticale. Protected against solid bodies $\phi \geq 12\text{mm}$ and against rain up to 60° from vertical axis.	IP55	Protetto contro la polvere e contro i getti d'acqua. - Dust-proof and splash-proof.
IP33	Protetto contro corpi solidi $\phi \geq 2,5\text{mm}$ e contro la pioggia fino a 60° dall'asse verticale. Protected against solid bodies $\phi \geq 2,5\text{mm}$ and against rain up to 60° from vertical axis.	IP65	Totamente protetto contro la polvere e contro i getti d'acqua. - Dust-tight and jet-proof.
IP40	Protetto contro corpi solidi $\phi \geq 1\text{mm}$. - Protected against solid bodies $\phi \geq 1\text{mm}$.	IP66	Totamente protetto contro la polvere e contro i getti d'acqua in pressione. Dust-tight and powerful jet-proof.
IP43	Protetto contro corpi solidi $\phi \geq 1\text{mm}$ e contro la pioggia fino a 60° dall'asse verticale. Protected against solid bodies $\phi \geq 1\text{mm}$ and against rain up to 60° from vertical axis.	IP67	Totamente protetto contro la polvere e stagno all'immersione. Dust-tight and water tight (immersible).
IP44	Protetto contro corpi solidi $\phi \geq 1\text{mm}$ e spruzzi d'acqua. Protected against solid bodies $\phi \geq 1\text{mm}$ and splash-proof.	IP68	Totamente protetto contro la polvere e stagno alla sommersione. Dust-tight and water tight (submersible).